

Probabilistic Based Optimized Adaptive Clustering Scheme for Energy-Efficiency in Sensor Networks

Vasudha

Department of Computer Science Engineering, Banasthali Vidyapith, Rajasthan, India.
vasudha.bahl@gmail.com

Anoop Kumar

Department of Computer Science Engineering, Banasthali Vidyapith, Rajasthan, India.
anupbhola@banasthali.in

Received: 14 April 2021 / Revised: 02 May 2021 / Accepted: 15 May 2021 / Published: 28 June 2021

Abstract – The key factor affecting the life span of the sensor network when node battery capacity is constrained is communication energy utilization. Although these networks are commonly used, they still require research to make full use of their outstanding features in communication. The utilization of energy is a major issue for which an optimization strategy to minimize energy usage and enhance the service life of the network is recommended. It was achieved by cultivating the energy balance of all Sensor Nodes (SNs) in clusters to reduce the dissipation of energy during data transmission. The aim of this paper is to implement an optimized refined probabilistic methodology to address the issue of how to conserve energy, maintain a balanced system throughput, and extend the lifespan of sensor network. The suggested scheme strengthens the Cluster Head (CH) selection threshold by taking into account the node's residual power, distance between the node, Base Station (BS), node dormancy mechanism and CH Re-election process. The proposed technique employs clustering with set time frame for transmission, which minimizes count of nodes involved in actual data transfer and will increase the lifespan. The proposed methodology helps to choose energy-aware CHs based on a fitness feature that takes SN's remaining energy and the neighboring SN's energy number. Furthermore, the proposed protocol L-DDRI's (LEACH -Distance Degree Residual Index) efficiency is measured against other common contemporary routing protocols such as Low-energy adaptive clustering hierarchy (LEACH), Uneven Clustering Strategy (UCS) and Distributed Energy-Efficient Clustering (DEEC). Analytical research and extensive simulation demonstrate shows improvement of proposed protocol L-DDRI in terms of lifespan, number of CHs, energy utilization, performance and overall reliability of the network and number of packets sent to Base station other existing technique.

Index Terms – Energy Efficiency, Cluster Head Selection, Distance Degree Residual Index (DDRI), Threshold.

1. INTRODUCTION

Wireless Sensor Networks (WSNs) are a series of a large count of sensor nodes (SNs) having restricted capacities for sensing, processing, and networking. Such SNs are spread

around a large area, with one or more Base stations (BS). With the development in technical knowledge, WSNs are commonly deployed to perform a necessary function as climate forecasting, environmental monitoring, petrol drilling, predictive farming, avoidance in natural disasters, energy, humidity and vegetation control, crisis prevention, military identification, forest fire tracking Compliance track. SNs are deployed automatically in most applications with insufficient battery capacity. The collection of route strategies is an essential problem for the optimal transmission of sensed data to target from its origin. The routing technique used in these networks would ensure minimal energy usage because of battery replacement. Depending on their implementation and network design, many energy-savvy routing protocols were proposed and developed for Wireless Sensor Network (WSN). The architecture of a routing protocol has problems, primarily due to insufficient space, poor transmission capacity, weak processing capacity, no traditional addressing system, overhead computing, and sensor node self-organization. Sensors, therefore, still have problems in field deployments like random formats and poor battery situations. Nevertheless, the major topic of WSNs is still increasing the performance of sensor nodes, growing the node energy usage, and expanding network time. The data transmission protocol's energy usage is essentially equal to the transmitting gap within WSNs. Then a routing protocol is used to reduce the excess energy loss, and more capacity is required for data transmission. Here two significant categories of routing protocols are implemented as flat routing and hierarchical routing protocols.

LEACH is a probabilistic routing protocol for cluster-based sensor networks. The CH of each cluster summarizes data obtained from nodes during the CH election process transmits to the BS [1]. The threshold value $T(n)$ given in equation 1 and random integer, r_i ($0 \leq r_i < 1$) define CH selection process. As $r_i \leq T(n)$ is fulfilled, the node is chosen as CH

RESEARCH ARTICLE

for the current Round. The restriction value $T(n)$ shall be determined as:

$$T(n) = \begin{cases} \frac{p}{1-p(r \times \text{mod}(\frac{1}{p}))}, & n \in F \\ 0, & \text{otherwise} \end{cases} \quad (1)$$

Here p is the percentage of the count of CHs to reflect the likelihood that every sensor nominated as CH in r [2], r is round count, F is nodes not suggested as CH in existent $1/p$ of r . The power amplifier energy usage is seen in comparison to the overall energy usage proportion over distance expressed in equation 2.

$$\text{ratio} = \begin{cases} \frac{m \times \epsilon_{fs} \times d^2}{m \times \epsilon_{elec} + m \times \epsilon_{fs} \times d^2}, & d \leq d_0 \\ \frac{m \times \epsilon_{fs} \times d^4}{m \times \epsilon_{elec} + m \times \epsilon_{mp} \times d^4}, & d > d_0 \end{cases} \quad (2)$$

This method implements the clustering principle and regular data processing, which can minimize the exchange of data between nodes and BS. This mechanism will also not only minimize power drain but can also prolong network existence. Additionally, the CH uses the data aggregation process to minimize clustered results. This approach will also maximize network data capacities and decrease energy usage. In addition, Time Division Multiple Access (TDMA) plan causes the participant nodes to go into sleep mode, and this process keeps off the cluster collision and increases the battery life of the sensors [3–5]. However, when choosing the CH, the node density is not included in the conventional algorithm. During CHs allocation, the location of nodes and estimated count of CHs/ r are addressed. This procedure cannot, however, guarantee that the CHs are distributed uniformly [6]. However, when choosing CH algorithm might not recognize the remaining node energy and the total energy of all nodes. It would result in a node being chosen as the CH with a reduced capacity. And this procedure contributes to the node capacity accelerated exhaustion [6]. Eventually, CH connects with BS explicitly by following a single mode of hop communications. If BS is distant from any CH, 80% of the node's energy usage comes from power failure of far distance transmission of data [7]. Under the concept of the free space channel, the energy utilization of the amplifier to the overall energy utilization ratio is approximately 80%, while d is 141 m. In comparison, the power amplifier energy utilization to the overall energy utilization ratio under the multi-path fading the channel model is around 80 percent when $d \approx 112m$. Thus, looking at actual implementations, an energy-efficient system needs to be built to reduce the WSN's energy loss. There are also certain drawbacks to it [8] like:

1. The remaining energy in the nodes is not taken into consideration when making the randomly generated CH method.

2. As the network size grows, CHs that are distant from BS quickly absorb more resources.
3. TDMA (Multiple Access Time Division) plans have several constraints: every CH requires its own period to collect the information in the assigned slot given the absence of recent data.
4. Many clusters will have more sensors than other clusters impacting the amount of data transfer to BS. Nodes in a compact cluster can consume energy more rapidly than nodes corresponding to a larger cluster.
5. The sensors produce a random integer, r_i ($0 \leq r_i < 1$), if r_i then the threshold, it acts as CH. So, CHs are generated with no constraint.
6. Sensor the node energy performance is influenced by the amount of usage of node as a CH.

1.1 Contributions of the Work

The enhanced algorithm succeeds in sufficiently expanding the network's lifespan, providing superior vitality skills and a longer lifetime of the system than traditional algorithms. An optimized algorithm is proposed in this paper to ensure the reliability and stability of the CH and better energy efficiency of the entire network.

The rest of this paper is structured into modules. In Section 2, discuss the relevant research and motivation in this area in a descriptive way. In Section 3, describe the network structure and energy model of the proposed technique. In Section 4, describe the proposed technique L-DDRI and its analytic description in detail. Discuss a comparative analysis in section 5 and an interpretation of the findings in section 6 to verify the proposed methodology. Finally, Section 7, offers the conclusion and future aspects.

2. RELATED WORK

Several researchers have studied the clustering routing mechanism based on the Probabilistic energy-efficient clustering technique. The methodology is implementing consistent clustering, maximizing the preference of the Cluster head and the headcount of the control cluster. Homogeneous clustering will manage energy demand in the hierarchical routing protocol, which causes CH to die early because of needless excessive energy utilization. UCS [9] builds clusters with non-uniform dimensions as per distance in CH and BS to optimize network resources. DK-LEACH changes the Count of CHs dynamically dependent on the propagation rate of the nodes, thereby allowing uniform energy spread [10]. Energy Efficient Clustering Scheme (EECS) [11] chooses CHs with higher leftover energy applying radio interaction for achieving a better distribution of clusters. LEACH-DCHS (Deterministic Cluster-Head Selection) [12], nodes with higher remaining energy are

RESEARCH ARTICLE

nominated through deterministic CH selection. LEACH protocol's option of CHs is random, and CH count varies tremendously.

Jiman et al. [13] proposed a collection of CHs based on the threshold. For the consecutive cycles, a CH chosen would stay as CH until its energy drops down by a maximum of 10 % of its initial energy value to save the energy expended on broadcasting CH's advertising in each cycle. Zhiyong et al. [14] developed a circular variable LEACH protocol by rendering a round-time CH rotation dependent on node energy and CH size. The movement of CH is variable from Round to round. Rui et al. [15] introduced the usage of distance threshold and energy-based threshold criteria CHs and choosing to align the gap between CHs. Sang et al. [16] introduced updated CH selection probability dependent on the difference between the predicted CHs at various distances from the BS and the non-CH nodes. This also uses multi-hop communication for the nodes situated well away from the BS. Khalid et al. [17] proposed an Adaptive energy-conscious cluster-based routing protocol for WSNs utilizing node degree criteria, node distance to BS, and node residual energy to maintain efficient cluster creation and cluster size distribution as well. It also accounts for preserving equal data traffic load by properly designing forwarding routes to prevent any node from wasting extra resources. The CHs are continuously rotated between nodes.

Stable election protocol (SEP) [18] is built heterogeneously for two-level networking. Centered on the sensor nodes' initial energies of each node is given an estimated probability. Since nodes have higher initial strength, an epoch of cluster creation for advanced nodes is reduced and has great chances to become CH. Enhanced-SEP (E-SEP) [19] is an improvement of the 3 stage SEP protocol Hierarchy in lieu of a Hierarchy with two tiers. E-SEP has three different degrees of original node energies. The Improvement nodes have initial energy double that of standard nodes, whereas intermediate nodes have an initial capacity of $1.5x$ with an increase in different energy rates within nodes, which improves the lifetime of the network.

DEEC protocol [20] is based on a clustering method, in which CHs are identified on the basis of remaining energy extensions and average sensor capacity. The epoch for each node is complex because of the various beginning and residual energy levels. Here nodes that stake both original and remaining resources have better odds of becoming CHs in comparison to low energy nodes. This idea is essentially close to SEP's, as the two proposals change each node's epoch to its capacity. TDEEC [21] constitutes an upgrade on the DEEC protocol implemented to adjust the threshold function for the node to be identified as the CH. It uses the same approach to measure the total energy in-network and to use it in the formulation threshold. At TDEEC, Currently, the trigger

calculation involves an energy element that makes sure nodes that have more remaining energy will become CH.

In [22], four separate clustering protocols were analyzed in the paper. The calculation was determined by the count of control packets, hops, live nodes, and distribution of data to BS and residual capacity. An enhanced methodology based on the adaptive clustering approach was suggested for hierarchical routing, which addresses the drawback that CH often designed cluster and absorbs loads of energy [23, 24]. In [25] introduced, it is important to consider the gap between CHs and BS as the key factor if the BS is placed beyond the network, far from direct node contact and counting other factors for clustering as well. If the network is tiny with smaller BS, then the distance from CM plays the same function as the distance from the nodes to BS as the clustering of unequal scale influences the subsequent nodes even more rapidly in the network. Energy-efficient Cluster-head Selection Technique (EECST) [26] eliminates the energy consumption needed to prolong the existence of the network. The methodology has three stages: choice of CHs based on remaining energy, aggregation routine, and retention of high remaining energy throughout the WSN. Episodic processing of CHs considering remaining energy results in a standardized allocation of energy usage across all SNs. An efficient CH choice (OCHS) [27] taking received signal strength index (RSSI) obtained from SNs from BS. The OCHS methodology considers optimizing the lifespan of the network dependent on RSSI values and SN's remaining energy. The criteria for CH selection in WSN have been stated in accordance with the categorization [28, 29, 30]. Network segregation and the creation of clusters inside the area resulted in improved coverage area across various regions. Besides this, BS performs CH selection and updating the nodes, reducing the load on SNs and lowering energy usage [31]. To reduce energy usage gives a sleeping-waking up scheduler [32].

Throughout the above-mentioned clustering protocols, there are several concerns about accurate CH collection, efficient cluster creation, and network administration. The CH election parameters are implicitly related to the probabilistic approach or associated with the probabilistic approach to the threshold. Through changing the CH selection criterion, the most suitable node can be identified as CH, Yet the internal expense decreases. Often, the node chosen as CH is in the area or in the region, which raises the network's energy usage and hence decreases network efficiency. So, the node with this location is unfit for CH's function. The nodes will also have stronger internal parameters and better communication with nodes, which are primarily situated inside the premise of the network. Hence, a stronger approach to CH selection improves network efficiency parameters. That and every algorithm described in the paper tried to modify the threshold function $T(n)$, and compared it to a random number dependent on a standard system of random number

RESEARCH ARTICLE

generation. In this paper, we suggested the procedure to use Gaussian random numbers to elect CH.

3. NETWORK MODEL AND ENERGY REPRESENTATION FOR PROPOSED TECHNIQUE

3.1. Network Model

Each SN comprises a node-information data packet, which includes details relevant to the respective SN. During cluster creation, all SNs transmitted their node-information data packet to all neighboring SNs. Before providing descriptions of the proposed work, the basic design issue of the proposed work is presented. The following conventions are considered for the design framework of the proposed protocol is shown in Figure 1.

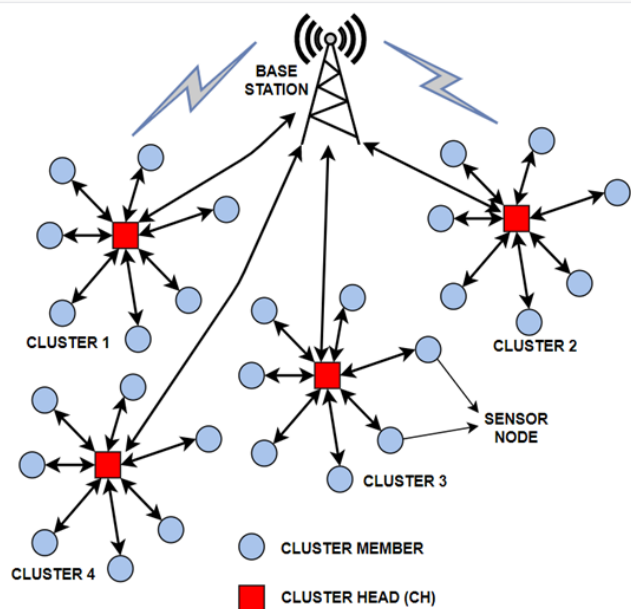

Figure 1 Network Architecture

- 1) The WSN consists of a significant number of SNs; that is, once deployed in a target area, the positions of the nodes can no longer shift.
- 2) The nodes organized in the tracking region are subject to some means of accessing their geographical details.
- 3) Every node shall have its own identifier dependent on the MAC address allocation techniques. To create the identifier of each node in the network, the MAC address is uniquely allocated.
- 4) In the control area, there is only one BS, and its location is set in the region.
- 5) Sensor nodes SN have heterogeneous amounts of energy, i.e., they have different initial energies.

- 6) The routing template for the network is based on a hierarchical routing protocol cluster consisting of a CH node and many non-CH nodes, considered regular nodes. First, the normal nodes send their sensing data to their respective CHs, where each CH node is responsible for the fusion and propagation of the data from the normal nodes to the BS.

3.2. Energy Consumption Model

The network configuration is considered a basic model where the radio dissipates E_{elec} is $50nJ/bit$ to operate the transmitter or to obtain the receiver circuit and ϵ_{amp} is $100pJ/bit/m^2$ transmitting amplifier. Figure 2 shows the energy consumption model for the radio equipment. The transmitter operates radio electronics and a power amplifier. Based on the distance between transmitter and receiver, the difference between the energy consumption units for the free space channel and the multi-path channel are d^2 and d^4 , respectively [33, 34].

Due to channel propagation, assume the loss of d^2 energy. Transmitting a k bit message over a distance d utilizing the radio model above must expend in equation 3,4:

$$E_{Tx}(k, d) = E_{elc} \times k + \epsilon_{elc} \times k \times d^\lambda \tag{3}$$

Receiving the message, radio expends:

$$E_{Rx}(k) = E_{elc} \times k \tag{4}$$

Here λ is the exponent of path loss, and conclude that the radio channel is symmetrical for a specified Signal to Noise Ratio (SNR). For short-distance transmission of nodes and CHs, the free-space model is considered, and the multi-path fading model follows for longer-distance communication from CHs to sink [35]. The power usage in the transmission of k bits to a sensor located d meters away can be written as for symmetrical propagation channel as in equation 5, equation 6, and equation 7:

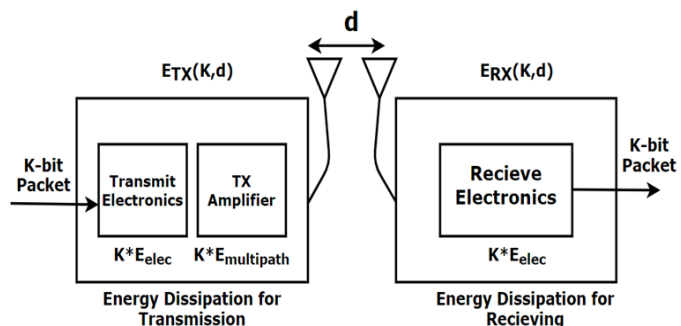

Figure 2 Energy Dissipation Model

$$E_{Tx}(k, d) = E_{Tx-elc} \times k + E_{Tx-m}(k, d) \tag{5}$$

$$E_{Tx}(k, d) = E_{ele} \times k + \epsilon_f \times k \times d^2, d \leq d_0 \tag{6}$$

RESEARCH ARTICLE

$$E_{Tx}(k, d) = E_{ele} \times k + \epsilon_m \times k \times d^4, \quad d \leq d_0 \quad (7)$$

Where it is possible to measure d_0 through $d_0 = \sqrt{\epsilon_f / \epsilon_m}$. The electronic energy E_{ele} is used as a method of digital coding, modulation, filtering, and signal distribution. The receiver's specific energy feature is the inverse of the transmitter, as seen in Figure 2. The specifications ϵ_f and ϵ_m are the transmission circuit amplification variables while $d \leq d_0$ and $d > d_0$ where d_0 is the threshold. The receiver's energy operating costs to obtain a package of k bits are in equation 8:

$$E_{Rx}(k) = E_{Rx-elc}(k) + E_{elc} \times k \quad (8)$$

E_{elc} is per bit energy usage by receiver or transmitter.

ϵ_m is multi-path fading transmission factor

ϵ_f is the free-space model.

3.3. Identification of the Optimal Count of Clusters

Considering n number of sensor nodes, so if the network is separated into clusters, the estimated count of nodes per cluster is $n = C$. In equation 9, energy utilization is given in a single frame in the CH [36].

$$E_{ch} = k \times E_{elc} \times \left(\frac{n}{C}\right) + k \times E_{da} \times \left(\frac{n}{C}\right) + k \times \epsilon_m \times d_{toBS}^4 \quad (9)$$

Here, E_{da} is the energy Utilization in aggregation and d_{toBS} is the average distance from the BS to CH. The energy consumption in non-CH [36] for transmission to CH is given in equation 10:

$$E_{n-ch} = k \times E_{elc} \times \left(\frac{n}{C}\right) + k \times \epsilon_f \times d_{toch}^2 \quad (10)$$

Where d_{toch}^2 is given in equation 11:

$$d_{toch}^2 = \left(\frac{M^2}{2\pi C}\right) \quad (11)$$

The average distance from non-CH to CH is given in equation 12:

$$d_{toBS} = 0.765 \times \frac{M}{2} \quad (12)$$

The area of each cluster is M^2 / C . The radius of the cluster is M/\sqrt{C}

Total cluster's energy dissipated (E_{Clst}) is represented in equation 13:

$$E_{Clst} = E_{ch} + E_{n-ch} \times \left(\frac{n}{C}\right) \quad (13)$$

Total energy dissipated (E_T) is represented in equation 14:

$$E_T = C \times E_{Clst} \quad (14)$$

By differentiating E_T w.r.t to C to zero, the optimum CH count (k_{op}) as equation 15:

$$k_{op} = (\sqrt{(n * \epsilon_f)}) / \sqrt{2\pi} * (1/\epsilon_m) * \left(\frac{M^2}{d_{toBS}^2}\right) \quad (15)$$

4. LEACH-DISTANCE DEGREE RESIDUAL INDEX (L-DDRI)

The CH selection parameters are implicitly related to the probabilistic method or associated with the probabilistic strategy to the threshold. By changing the classification criterion for CH, the most suitable node can be chosen to be CH. Moreover, the clustering mechanism of the probabilistic procedure can also be enhanced either by integrating any approach together by the uniform random number generation system. This modified random number is contrasted with the $T(n)$ threshold to determine if a node is to be employed as CH or not. Protocols are introduced to enhance the algorithm by obtaining random numbers instead of the standard system of random numbers for choosing CH. The algorithm is expanded in this segment to see the impact of random numbers on the CH electoral mechanism. Such random numbers are obtained with the Gaussian Random Number Generator, which extracts random numbers from a regular distribution and is stronger than the pseudo-random number implementations usually used in computer programs for several purposes.

A node extracts a random number (R_d) from 0 to 1, at the starting of every Round. This R_d , is obtained through normal distribution with mean 0 and variance 1. The R_d needs to be $0 < R_d < 1$; alternatively, the node chooses a new R_d . The node completes this cycle until a random number is located in the range of 0 to 1. After R_d generated, it is contrasted with $T(n)$ level. If the $R_d \leq T(n)$ a node nominates itself as a CH, then it must function as a participant (non-CH node) for the current Round. The CH contacts other nodes inside the network regarding its status. Non-CH node chooses one of the CH nodes that need the least communicating resources and sends a connect notification to the chosen CH. CH plan TDMA schedule after obtaining link messages from the non-CH nodes and notify member nodes of their cluster. The key limitation is choosing randomized CH without considering any parameter. In fact, it is needed to change the threshold of elected CH to maximize the lifespan of the network and the energy output. In other terms, three main criteria will be considered: the range between node and BS, the remaining energy, and neighbor's node count within the cluster range for measuring the level of threshold.

The further residual energy of the node along with the alive neighbors count optimized the CH selection process. Moreover, nodes having at the same residual energy simultaneously, less distant node to sink, and suitable alive neighbors count act as CH.

RESEARCH ARTICLE

The electoral mechanism of CH is dependent on the newly developed node index variable (N_i) deduced from currently available energy, initial energy, alive node count, and hop count from BS. In this technique [37], remodeled the threshold value as deciding factor for a node to be chosen as CH. By incorporating the above criteria, incorporate node index (N_i) which is expressed in equation 16:

$$N_i = \alpha \frac{E_{res}^n}{E_{in}[n]} + \rho \left(1 - \left(\frac{Degree[n]}{N_{alv}} \right) \right) + \varphi \left(1 - \frac{d_{toBS}[n]}{d_{toBSrmax}[n]} \right) \tag{16}$$

Where E_{res}^n is residual energy of node n , E_{in} is initial energy, N_{alv} is alive nodes count, $d_{toBS}[n]$ is the distance from node n to BS, and $d_{toBSrmax}[n]$ is node range limit to BS. So, the modified threshold Equation given equation 17 is:

$$T(S_i) = \frac{P_i}{1 - P_i \times \left(r \times \text{mod} \left(\frac{1}{P_i} \right) \right)} \times \alpha \frac{E_{res}^n}{E_{in}[n]} + \rho \left(1 - \left(\frac{Degree[n]}{N_{alv}} \right) \right) + \varphi \left(1 - \frac{d_{toBS}[n]}{d_{toBSrmax}[n]} \right), \text{ if } S_i \in G \tag{17}$$

4.1. L-DDRI Algorithm

1. Initialize the network parameters for WSN and apply unequal clustering for randomized positioning of nodes in the network.

i. Compute residual energy and average energy of node n as in equation 18 and equation 19 respectively, initial energy, N_{alv} alive nodes count.

$$E_a^n = E_{in} \times \left(1 - \frac{r/r_{max}}{n^i} \right) \tag{18}$$

$$E_{res}^i(l, d_{toBS}, n^i) = E_a^n - E_{en}^{con^i} \tag{19}$$

Here, E_{res}^i is residual energy, $E_{en}^{con^i}$ is consumed energy, and E_a^n is the average energy of node n in i^{th} iteration.

ii. Compute $d_{toBS}[n]$ is the distance from node n to BS, and $d_{toBSrmax}[n]$ is the node range limit to BS. Sort the nodes based on the distance from BS applying Bubble Sort. Node-distance from BS is represented as follow in equation 20:

$$d_{toBS}[n] = \frac{P_i}{\sqrt{((S(n) \times x_d(\text{sink} \times x))^2 + ((S(n) \times y_d(\text{sink} \times y))^2)}} \tag{20}$$

iii. In the Initialization phase, Radio radius, $R(n)$ as in equation 21 and information collection within maximum range to BS (D_m), maximum radius, and weighted estimation to adapt the percentage of energy and distance.

$$R(n) = \left(\gamma \frac{E_{res}^n}{E_{in}[n]} + \beta \frac{d_{toBS}[n]}{D_m[n]} \right) \times R_m \tag{21}$$

Where γ and β are weighted values to adjust the proportion of energy and distance, and R_m is the threshold of cluster radius. Here $0 < \beta \leq 1$, $0 \leq \gamma < 1$, $\beta + \gamma = 1$.

iv. Each node computes a time interval given in equation 22, $time(n)$ based on residual energy (E_{res}^n), average energy (E_a^n) consumed by a cluster in one round and preset threshold of time interval, T_C and random factor (φ), that varies between 0 to 0.5. when the SNs are having the same E_{res} then φ will help in reducing the communication conflicts.

$$time(n) = \left(1 - \left(\frac{E_{res}^n}{E_a^n} \right) \right) \times T_C[i] + \varphi[i] \tag{22}$$

In case once the Packet is received within the limits of time interval, $time(n)$ it adds n to its list of CCH.

v. Newly developed node index variable, N_i deduced from currently available energy, initial energy, alive node count, and hop count from BS. By integrating the metrics, node index (N_i) is computed.

If node received is in the range of time interval, $time(n)$, and more than node is in CCH then selection criteria will Sort the nodes based on the E_{res}^n ; again, if greater than one node is in the list, the selection criteria further extended on the basis of max node index. If the same condition of more than one persisted, then consider node with min id a selected node. This process will generate a list of eligible nodes in a sorted list for further computations.

During the setup phase, each node generates a random number R_d . This R_d is generated using a normal distribution with mean 0 and variance 1. If $0 < R_d < 1$ otherwise a new R_d is suggested for node.

2. After R_d is obtained, it is in contrast with threshold $T(n_i)$. A node elects itself as CH, if the $R_d < T(n_i)$, otherwise it works as non-CH for current round r . The improvement of this algorithm is mainly about the selection of CHs. The proposed a novel modified threshold formula $T(n_i)$ is as equation 23:

$$T(n_i) = \frac{P_i}{1 - P_i \times \left(r \times \text{mod} \left(\frac{1}{P_i} \right) \right)} \times N_i, \text{ if } n_i \in G$$

$$T(n_i) = \frac{P_i}{1 - P_i \times \left(r \times \text{mod} \left(\frac{1}{P_i} \right) \right)} * \alpha \frac{E_{res}^n}{E_{in}[n]} + \rho \left(1 - \left(\frac{Degree[n]}{N_{alv}} \right) \right) + \varphi \left(1 - \frac{d_{toBS}[n]}{d_{toBSrmax}[n]} \right), \text{ if } n_i \in G \tag{23}$$

Where P : Percentage of CH, r : current round count, G : set of nodes not chosen as CHs in previous $1/p$ rounds. CH broadcast its status to all members in-network.

RESEARCH ARTICLE

3. Eventually, to shape the initial cluster, every node is connected to the closest CH as per Euclidean distance and sends a join packet to the elected CH.

4. CH plans TDMA schedule after obtaining link messages from the non-CH nodes and notifies member nodes of their own cluster.

Pseudocode of the proposed L-DDRI is given in Algorithm 1 and data flow given in Flowchart 1.

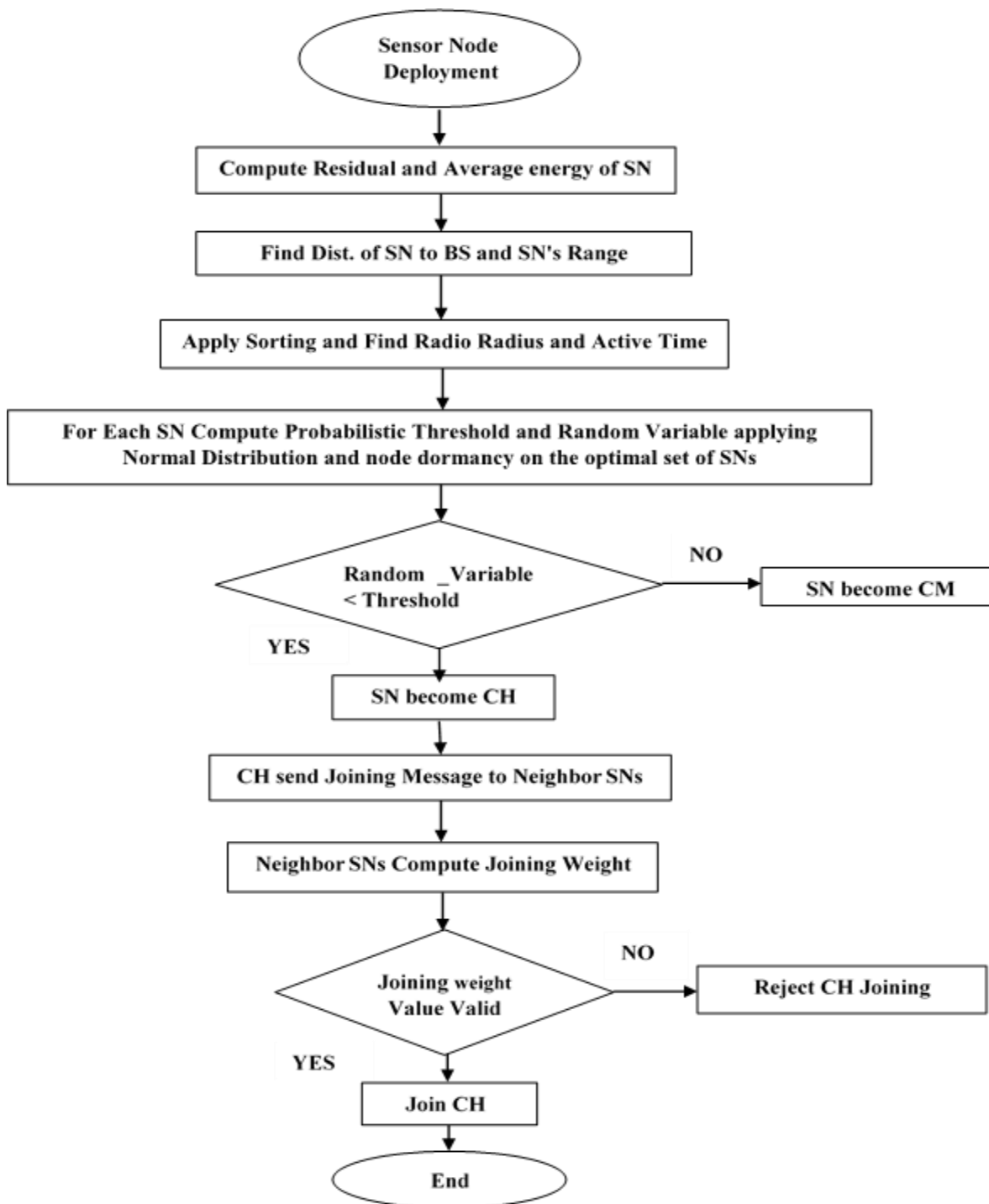

Flowchart 1 L-DDRI CH Selection

RESEARCH ARTICLE

 L-DDRI Algorithm: Modified Threshold $T(n_i)$

 Procedure: Initialize CH_Selection ($R_d, E_a^n, E_{res}^i, d_{toBS}$)

Parameters:

n ← Sensor Nodes
 R_d ← Random Num based on normal distribution
 $E_{in}[n]$ ← Initial Energy of node n
 E_a^i ← Average Energy of node n in i^{th} iteration
 E_{res}^i ← Residual Energy of node n in i^{th} iteration
 d_{toBS} ← Distance to BS

Pseudocode: L-DDRI Algorithm:

Algorithm BEGIN
// Initialization Phase

 for each n in each Cluster

 for $i := 0$ to r // r count of rounds

Assign initial energy to sensor nodes:

 $E_{in}[n] = E_0, n = 1, 2, 3, \dots$
 $E_a^i = E_{in} \times \left(1 - \frac{r/r_{max}}{n^i}\right)$
 $E_{res}^i(l, d_{toBS}, n^i) = E_a^i - E_{en}^{con^i}$

 Compute $d_{toBS}[n] =$
 $\sqrt{((S(n) \times x_d(\text{sink} \times x))^2 + ((S(n) \times y_d(\text{sink} \times y))^2}$

end for

end for

// Model Building Phase:

 for each cluster, all n will compute the following:

 for $i := 0$ to r

 Sort ($d_{toBS}[n]$)

 $R(n) = \left(\gamma \frac{E_{res}^n}{E_{in}[n]} + \beta \frac{d_{toBS}[n]}{D_m[n]}\right) \times R_m$ // Radio radius

 $time(n) = \left(1 - \left(\frac{E_{res}^n}{E_a^n}\right)\right) \times T_C[i] + \varphi[i]$ // Active time

end for

end for

// Working Phase:

 for each cluster, each n will compute

 for $i := 0$ to r

$$N_i = \alpha \frac{E_{res}^n}{E_{in}[n]} + \rho \left(1 - \left(\frac{Degree[n]}{N_{alv}}\right)\right) + \varphi \left(1 - \frac{d_{toBS}[n]}{d_{toBSrmax}[n]}\right)$$

// node index

$$T(n_i) = \frac{P_i}{1 - P_i \times \left(r \times \text{mod}\left(\frac{1}{P_i}\right)\right)} \times N_i, \text{ if } n_i \in G$$

// modified threshold

 $R_d = \text{rand}(1);$

// random number is extracted applying normal distribution with mean 0 and variance 1.

 if ($R_d < T(n_i)$)

 $CH(n^i) \leftarrow 1$ //node n be a CH

else

 $CH(n^i) \leftarrow 0$ //node n be a CM

end if

end for

end for

 if ($CH(n^i) == T$) then

 $Broadcast(adv) \leftarrow \text{transmit announcement packet}$

 If ($receive\ CH_msg \ \&\&state! =$
 $CH \ \&\& \ \text{has not send join_msg}$)

 if ($CH\ advToBSi > Avg(advToBS) \ \&\& \ D < D_m$)

 $Join(cluster) \leftarrow CM^i$

end if

end if

end if

END Algorithm

Algorithm 1 L-DDRI Algorithm

5. PERFORMANCE EVALUATION

The proposed L-DDRI technique is implemented with the aim of improving the energy efficiency of the clustered sensor-based network. It identifies cluster heads based on the residual energy level of nodes, distance, degree, and a minimum number of clusters per Round. Each segment discusses the development framework, the setting for simulation, and the efficiency metrics.

RESEARCH ARTICLE

5.1. Simulation Parameters and Setup

L-DDRI is simulated and examined using MATLAB described in two simulation scenarios. The experiment is initially conducted with a variety of nodes ranging from 25 to 100 placed in $100\text{ m} \times 100\text{ m}$ of area. It is assumed that every node has initial energy of 0.5 J . Next, analysed the performance of L-DDRI with LEACH, UCS, and DEEC. In both scenarios, the BS location is taken in the center of the sensing field, and protocol performance is presented in terms of the number of CHs per Round, network lifetime, Packet’s arrival rate, and energy consumption. Table 1 shows the network simulation parameters.

Parameter	Value
Initial Energy, E_{in}	0.5 nJ
Energy of transmitting each bit, E_{Tx}	50 nJ/bit
Energy of receiving each bit, E_{Rx}	50 nJ/bit
Data aggregation energy, E_{da}	5 nJ/bit/signal
Count of iterations, r	5000
Count of sensor nodes, n	100
Data packet to CH	2000 bits
Data packet from CH to BS	6400 bits
Node distribution	Random distribution
Communication radius, R_m	20 m

Table 1 Initial Values for Simulation Parameters

5.2. Performance Metrics

The performance of the proposed L-DDRI technique has been evaluated by comparing with LEACH, UCS, and DEEC for different performance metrics. Following performance metrics are used to evaluate the performance of the proposed technique.

5.2.1. CH Count Per Round

The node count which transmits collected data to BS from their members is chosen according to $T(n_i)$ threshold function. This can be determined in various channel models through equation 24.

$$k_{op} = (\sqrt{(n * \epsilon_f)}) / \sqrt{2\pi} * (1/\epsilon_m) * (\frac{M^2}{d_{toBS}^2}) \quad (24)$$

5.2.2. Stability Period and Network Lifetime

Stability Period: The time period from the initiation of networking service to FND occurs, which can be measured by given in equation 25:

$$T_{stability} = t_{FND} - t_{start} \quad (25)$$

Where $t_{FND} = 20 \times \text{FND}$, t_{FND} is the moment when FND (First Node Dead) happened, and t_{start} is the period when network service begins.

Network Lifetime: The period ranges from the start of network service until the last live SN dies, which can be determined by equation 26:

$$T_{Lifetime} = t_{LDN} - t_{start} \quad (26)$$

Where $t_{LDN} = 20 \times \text{LND}$ (Last Node Dead) and t_{LDN} is the moment, all the SNs died.

5.2.3. Energy Consumption

WSN's energy utilization mainly considers the energy usage of circuits and power amplifiers. Equation 7 measures the energy usage of each Round inside the network in various channel models. For every packet transmission, a specific rate of energy is fallen. The energy rate is therefore determined based on the total simulation time provided is given in equation 27.

$$\text{Energy} = \frac{\text{amount of energy for every packets}}{\text{total simulation time}} \quad (27)$$

6. RESULTS AND DISCUSSIONS

Simulations are considered for all sensors deployed (x, y) where $(x_i = 0, y_i = 0)$ and $(x_j = 100, y_j = 100)$ and BS positioned at $(50, 75)$ free space model $\epsilon_f d^2 = 10\text{ pJ/bit/m}^2$, multi-path fading model $\epsilon_m d^4 = 0.0013\text{ pJ/bit/m}^4$, taking these variables, the estimated count of CH lies as $0 < \text{CH} < 5$. Simulations identified analytically results that the optimal count of CHs is computed between 1 to 5, Thus, consider $C = 4$. Figure 3 shows sensor network deployed in simulations of network model.

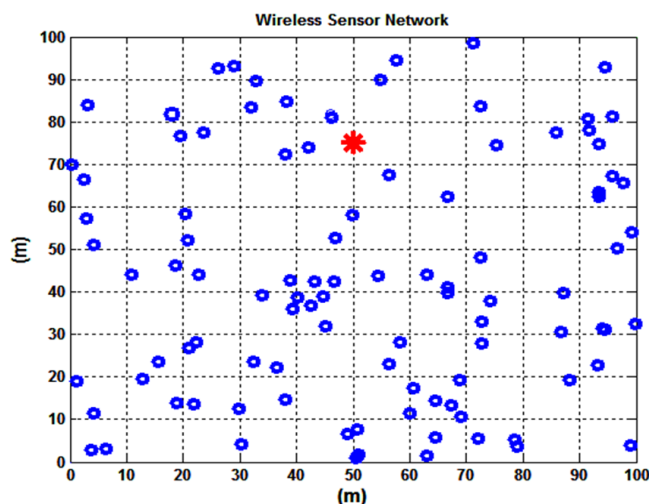

Figure 3 Sensor Network (100 m x 100 m)

RESEARCH ARTICLE

6.1. Comparison of CH Count Per Round

Cluster head stabilization counts significantly impact the protocol's energy performance. If the number of CHs is smaller, the duration of data transfer of nodes to CH would be too long, resulting in additional energy usage, so the unnecessary data that the cluster head consumes to transmit would allow it to consume extra energy. If the total of CHs is high, overall network load is raised, the average energy usage of each network round shoots up, the capacity of network data fusion is reduced; thus, network's lifespan reduces. Figure 4-6 displays the LEACH, UCS, DEEC, and LEACH-DDRI

protocol headcount per Round for cluster. The CH variation in the proposed L-DDRI provides improved outcomes in contrast with others, as shown in the graph. CH count varies in the context of LEACH protocol between $5 \leq c \leq 18$ and L-DDRI protocol from $1 \leq c \leq 5$. The L-DDRI protocol requires measuring optimum CH count dependent on WSN's energy demand per Round, thus reducing cluster headcount randomness. Stabilizing CH count in L-DDRI is relevant related to node death. If WSN includes a significant dead node count so to support the network's energy usage, the overall cluster bandwidth would be decreased accordingly.

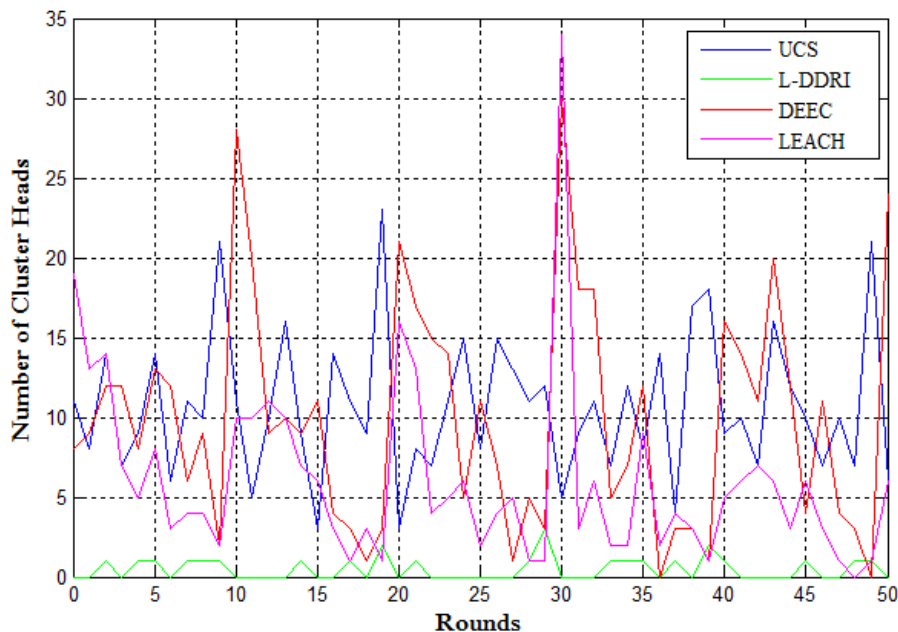

Figure 4 Performance Comparison of Cluster Head Count Considering $r = 50$

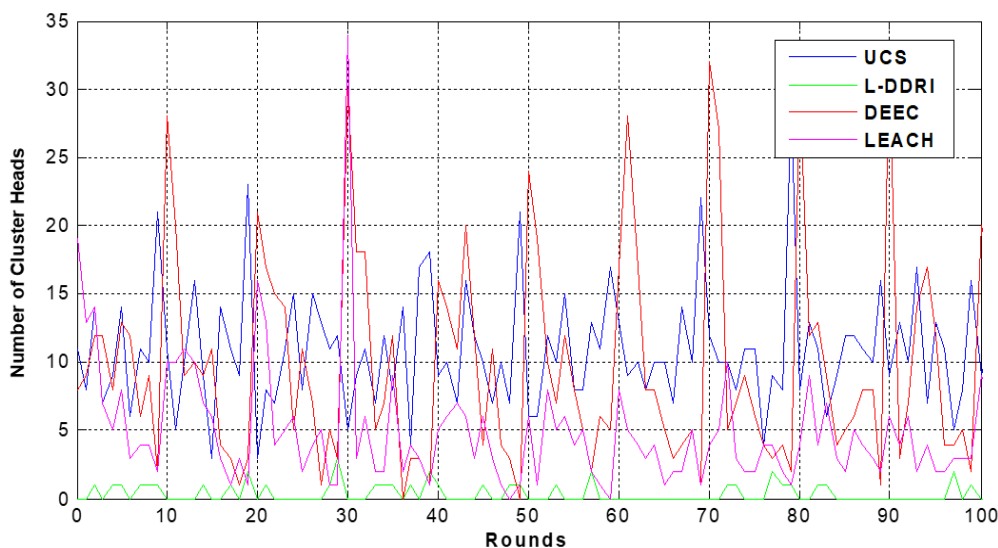

Figure 5 Performance Comparison of Cluster Head Count Considering $r = 100$



RESEARCH ARTICLE

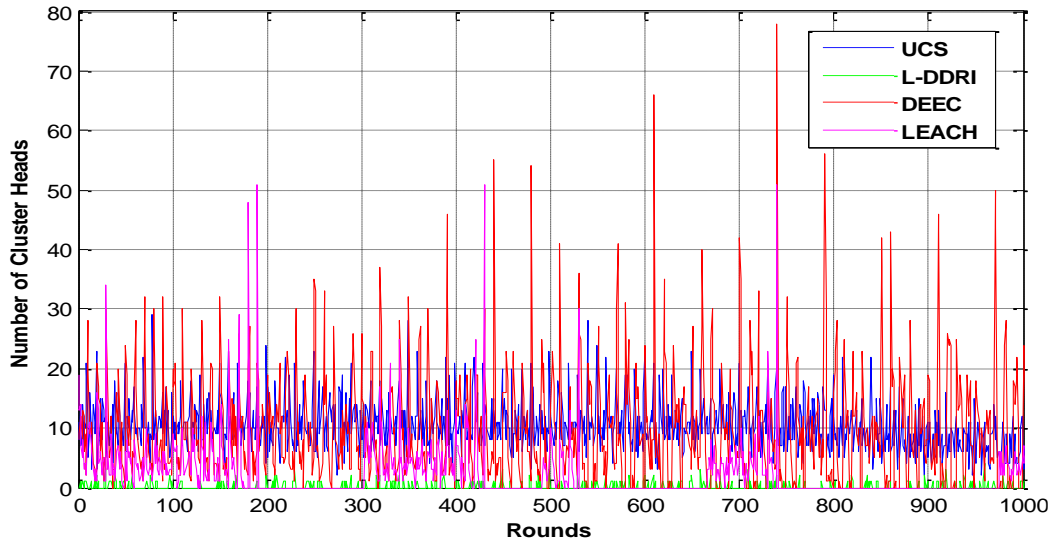

Figure 6 Performance Comparison of Cluster Head Count Considering $r = 1000$

6.2. Comparison of Stability Period and Network Lifetime

With this measuring variable tracked the WSN area's life cycle as stable time span and unstable phase. The interval between LND and FND signifies unpredictable duration. It is primarily used in the domain of environmental management, and the positioning of sensor nodes involves a wide range. Because of the huge distribution field, if large-range nodes die, any data gathered cannot correctly determine the environmental parameters. This paper, therefore, analyses the

lifespan of the network according to FND to determine L-DDRI has remarkable influence in contrast with the other protocols. Figure 7 demonstrates alive node count over rounds in LEACH, UCS, DEEC, and L-DDRI. In comparison, it shows proposed L-DDRI improved FND by 57%. The approach presented has now strengthened efficiency in the stabilization process. Enhanced efficiency is the cause of constant CH count, and the L-DDRI protocol eliminates these variations.

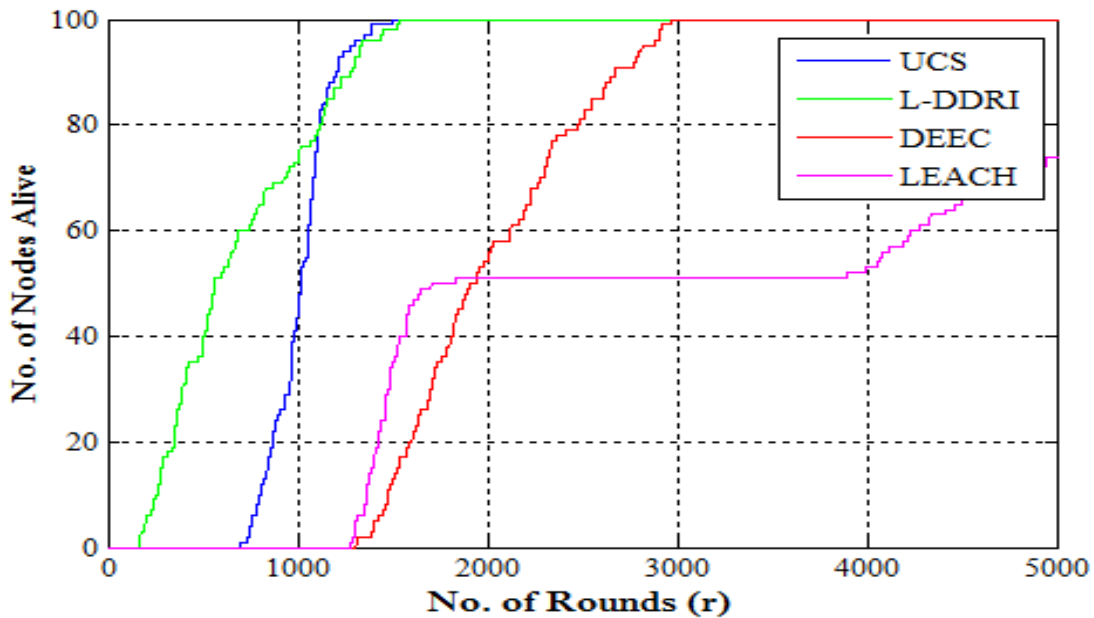

Figure 7 Performance Comparison of Network Lifetime



RESEARCH ARTICLE

6.3. Comparison of Packets Arrival Rate at BS

One of the metrics for determining the high rate of energy consumption is the BS packet arrival rate. The more structured the delivery of resources throughout the network, the more packets the BS gets. Figure 8 and 9 indicates the count of packets obtained at BS for protocols LEACH, UCS

and DEEC, and L-DDRI, where the duration of one Packet is 2000/bit. L-DDRI raises the number of packets provided at the BS by 42.4% compared with all. The substantial improvement in packet computation obtained by BS is attributed to a decrease in the probability of CH and an efficient decline in energy usage in a managed cluster interaction.

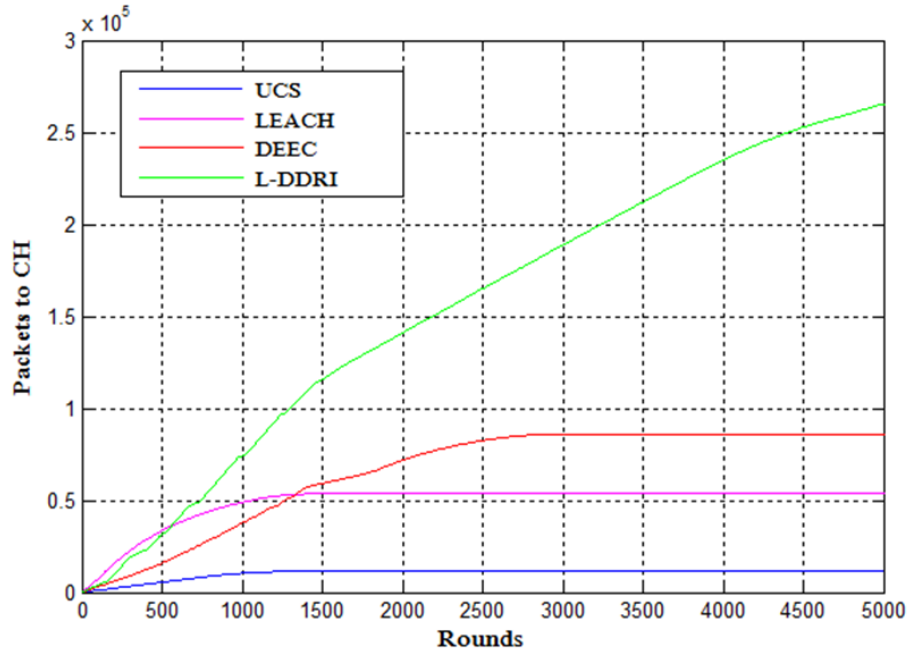

Figure 8 Performance Comparison of Packets to CH Per Round

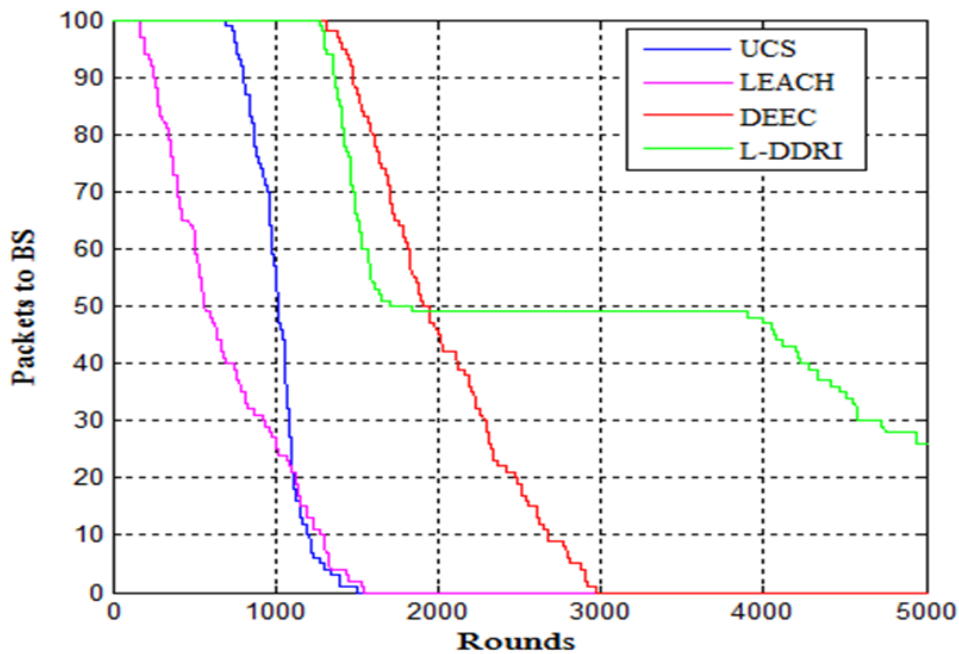

Figure 9 Performance Comparison of Data Transmission

RESEARCH ARTICLE

6.4. Comparison of Energy Consumption

Energy utilization relates to the cumulative resources used by the network for transmission, reception, and processing of results. The contrasts between the various methods were rendered based on the energy usage of both CH and Cluster members. As shown in Figure 10, the L-DDRI strategy achieves minimal energy usage.

These results are possible to accomplish as our method changes the number of clusters in each round for energy load equality. Besides that, the SNs that become CHs are dynamically selected. As a consequence, the functions of SNs can be switched every round to obtain a communication protocol that uses less energy and lasts longer. The evolved model includes additional parameters that influence CH choice, resulting in an optimum cluster organization that uses minimal energy per round.

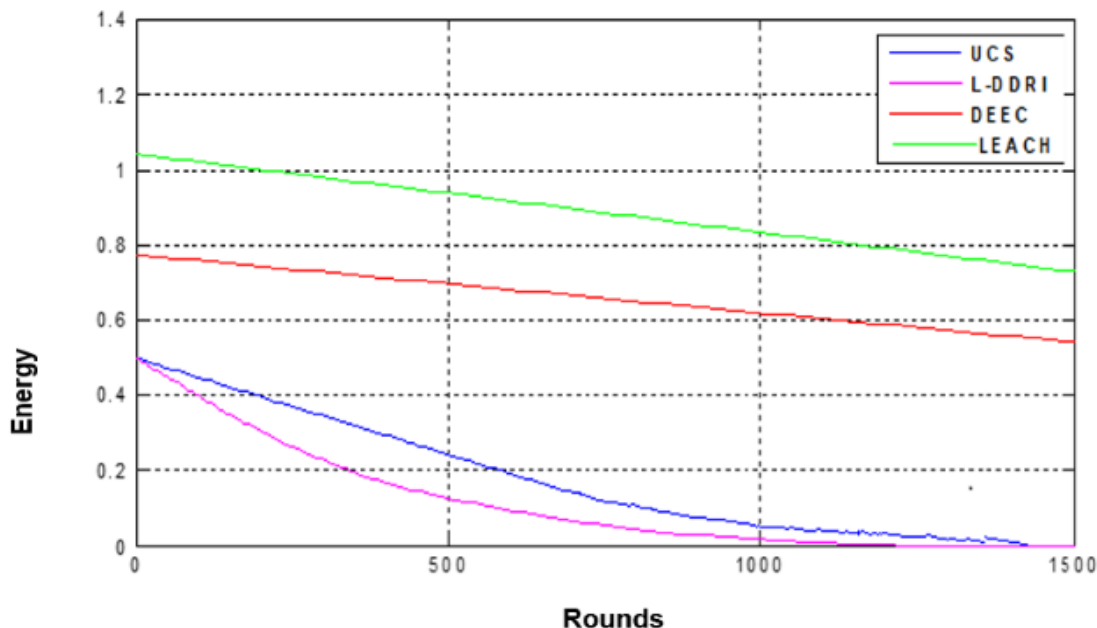

Figure 10 Performance Comparison of Energy Consumption

7. CONCLUSION AND FUTURE SCOPE

The key concerns affecting the WSN include energy consumption, node life cycle, network, and system stability and performance. Clustering is commonly used to minimize energy usage and enhance network stability. The effective routing protocol plays a key role in preserving the cluster and its node's resources and stabilization. In this paper, an optimal solution has been suggested to strengthen the routing protocols based on probabilistic adaptive clustering. It is based on dynamically changing CH election probability. The approach intends to choose the correct cluster head node at each Round for each cluster. It is achieved by adjusting the threshold for CH selection with R_d obtained through normal distribution.

Based on the residual energy level of nodes and the total number of clusters per Round, it selects cluster heads. The L-DDRI is simulated using MATLAB and found to be performing stronger in terms of stability and network lifespan than LEACH, UCS, and DEEC. Proposed approach L-DDRI builds a more stable routing environment. For the future, the

proposed methodology is collaborated with intelligent algorithms for adaptive heuristic clustering and applied in practice.

REFERENCES

- [1] I. Sohn, J. Lee, S. H. Lee, "Low-Energy Adaptive Clustering Hierarchy Using Affinity Propagation for Wireless Sensor Networks," in IEEE Communications Letters, vol. 20, no. 3, pp. 558-561, March 2016. doi: 10.1109/LCOMM.2016.2517017.
- [2] Alnawafa, E., Marghescu, I., "New Energy Efficient Multi-Hop Routing Techniques for Wireless Sensor Networks: Static and Dynamic Techniques", Sensors 2018, 18, 1863. <https://doi.org/10.3390/s18061863>
- [3] Hongju Cheng, Zhihuang Su, Naixue Xiong, Yang Xiao, "Energy-efficient node scheduling algorithms for wireless sensor networks using Markov Random Field model", Information Sciences, Volume 329, pp.461-477, 2016. doi.org/10.1016/j.ins.2015.09.039.
- [4] D. C. Hoang, P. Yadav, R. Kumar and S. K. Panda, "Real-Time Implementation of a Harmony Search Algorithm-Based Clustering Protocol for Energy-Efficient Wireless Sensor Networks," in IEEE Transactions on Industrial Informatics, vol. 10, no. 1, pp. 774-783, Feb. 2014, doi: 10.1109/TII.2013.2273739.
- [5] Noh, Y.; Lee, D., "BCoPS: An energy-efficient routing protocol with coverage preservation", IET Communications 2017, Volume 11, Issue 12, pp. 1933 – 1940, 24 August 2017.

RESEARCH ARTICLE

- [6] Hongxia Miao, Xuanxuan Xiao, Bensheng Qi and Kang Wang, "Improvement and application of LEACH Protocol based on Genetic Algorithm for WSN," 2015 IEEE 20th International Workshop on Computer Aided Modelling and Design of Communication Links and Networks (CAMAD), Guildford, UK, 7–9 September 2015, pp. 242–245, 2015. doi: 10.1109/CAMAD.2015.7390517.
- [7] Zhang, Yiming; Liu, Mandan; Liu, Qingwei., "An Energy-Balanced Clustering Protocol Based on an Improved CFSFD Algorithm for Wireless Sensor Networks" *Sensors* 18, no. 3: 881, 2018. <https://doi.org/10.3390/s18030881>
- [8] M. Shurman, N. Awad, M. F. Al-Mistarihi and K. A. Darabkh, "LEACH enhancements for wireless sensor networks based on energy model," 2014 IEEE 11th International Multi-Conference on Systems, Signals & Devices (SSD14), pp. 1–4, 2014. doi: 10.1109/SSD.2014.6808823.
- [9] Mazumdar, N, Om, H., "Distributed fuzzy approach to unequal clustering and routing algorithm for wireless sensor networks". *International Journal of Communication Systems*, Vol. 31, Issue 12, 2018. doi.org/10.1002/dac.3709
- [10] Ding, XX., Ling, M., Wang, ZJ. & Song, F., "DK-LEACH: An Optimized Cluster Structure Routing Method Based on LEACH in Wireless Sensor Networks". *Wireless Personal Communications*, Volume 96, pp 6369-6379, 2017. <https://doi.org/10.1007/s11277-017-4482-y>
- [11] Mao Ye, Chengfa Li, Guihai Chen and J. Wu, "EECS: an energy efficient clustering scheme in wireless sensor networks," *PCCC 2005. 24th IEEE International Performance, Computing, and Communications Conference*, pp. 535-540, 2005. doi: 10.1109/PCCC.2005.1460630.
- [12] Y. Liu, J. Gao, Y. Jia, et al., "A cluster maintenance algorithm based on LEACH-DCHS protocol", *Computer Engineering & Applications* 45(30), Palladam, INDIA, pp.165–166, 2009.
- [13] H. Jiman, K. Joongjin, L. Sangjun, K. Dongseop, & Y. Sangho, "T-LEACH: The method of threshold-based cluster head replacement for wireless sensor networks", *Information Systems Frontiers*, volume 11, pp.513-521, 2009.
- [14] P. Zhiyong & L. Xiaojuan, "The improvement and simulation of LEACH protocol for WSNs", *IEEE International Conference on Software Engineering and Service Sciences*, Beijing, China, pp. 500-503, 2010.
- [15] R. Hou, W. Ren and Y. Zhang, "A Wireless Sensor Network Clustering Algorithm Based on Energy and Distance," 2009 Second International Workshop on Computer Science and Engineering, pp. 439-442, 2009. doi: 10.1109/WCSE.2009.705.
- [16] S. H. Kang and T. Nguyen, "Distance Based Thresholds for Cluster Head Selection in Wireless Sensor Networks," in *IEEE Communications Letters*, vol. 16, no. 9, pp. 1396-1399, September 2012. doi: 10.1109/LCOMM.2012.073112.120450.
- [17] Haseeb, K., Bakar, K.A., Abdullah, A.H. & Darwish, T., "Adaptive energy aware cluster-based routing protocol for wireless sensor networks", *Wireless Network*, Vol 23, pp 1953–1966, 2017.
- [18] Smaragdakis, G., Matta, I., & Bestavros, A., "2004-05-31 SEP: A Stable Election Protocol for clustered heterogeneous wireless sensor networks" OpenBU, 2004.
- [19] M M Islam, M A Matin, T K Mondol, "Extended Stable Election Protocol(SEP) for Three level Hierarchical Clustered Heterogeneous WSN", *IET onference on Wireless Sensor Systems(WSS 2012)*, 18-19 June 2012, London, UK, 2012.
- [20] F. Javeed, A. Naz, T. N. Qureshi, A. Basit and N. Iltaf, "A review on variant clustering designs in heterogeneous WSNs," 2015 National Software Engineering Conference (NSEC), pp. 48-54, 2015. doi: 10.1109/NSEC.2015.7396344.
- [21] Parul Saini, Ajay K Sharma, "Energy Efficient Scheme for Clustering Protocol Prolonging the Lifetime of Heterogeneous Wireless Sensor Networks", *International Journal of Computer Applications*, Volume 6– No.2, pp30-36, September 2010.
- [22] Omari, M., & Laroui, S., "Simulation, comparison and analysis of wireless sensor networks protocols: LEACH, LEACH -C, LEACH-1R, and HEED", 2015 4th International Conference Electrical Engineering (ICEE), pp. 1–5, 2015.
- [23] Y.-Z. Li, A.-L. Zhang, Y.-Z. Liang, "Improvement of LEACH protocol for wireless sensor networks", *Third International Conference on Instrumentation Measurement Computer Communication and Control*, pp. 322–326, 2013.
- [24] H.Liang, S.Yang, L. Li, et al. " Research on routing optimization of WSNs based on improved LEACH protocol" *EURASIP Journal on Wireless Communications and Networking* , pp-194, 2019.
- [25] Remika Ngangbam, Ashraf Hossain & Alok Shukla, "Improved low energy adaptive clustering hierarchy and its optimum cluster head selection", *International Journal of Electronics*, 107:3, 390-402,2019. doi:10.1080/00207217.2019.1661023
- [26] Jain K., Kumar A., Jha C.K. (2020) Probabilistic-Based Energy-Efficient Single-Hop Clustering Technique for Sensor Networks. In: Bansal J., Gupta M., Sharma H., Agarwal B. (eds) *Communication and Intelligent Systems*. ICCIS 2019. *Lecture Notes in Networks and Systems*, vol 120. Springer, Singapore, 2020. https://doi.org/10.1007/978-981-15-3325-9_27
- [27] K.Jain, and A.Kumar, "An optimal RSSI-based cluster-head selection for sensor networks", *International Journal of Adaptive and Innovative Systems*, Vol.2 No.4, pp.349 - 361, 2019.
- [28] Alghamdi, T.A., "Energy efficient protocol in wireless sensor network: optimized cluster head selection model", *Telecommunication Systems*, volume 74, pages331–345, 2020.
- [29] Ramadhani Sinde, Feroza Begum, Karoli Njau, Shubi Kajjage | Kuei-Ping Shih (Reviewing editor), "Lifetime improved WSN using enhanced-LEACH and angle sector-based energy-aware TDMA scheduling", *Cogent Engineering*, 7:1, 1795049, 2020, DOI: 10.1080/23311916.2020.1795049
- [30] Amir Abbas Baradaran, Keivan Navi, "HQCA-WSN: High-quality clustering algorithm and optimal cluster head selection using fuzzy logic in wireless sensor networks", *Fuzzy Sets and Systems*, Vol 389, pp 114-144,2020.
- [31] Hamid Reza Farahzadi, Mostafa Langarizadeh, Mohammad Mirhosseini, Seyed Ali Fatemi Aghda, "An improved cluster formation process in wireless sensor network to decrease energy consumption", *Wireless Networks*, volume 27, issue 2, pages1077–1087, 2021.
- [32] Safa'a S. SalehTamer F. MabroukRana A. Tarabishi, "An improved energy-efficient head election protocol for clustering techniques of wireless sensor network", *Egyptian Informatics Journal*,2021, doi.org/10.1016/j.eij.2021.01.003
- [33] TM Behera,UC Samal, S.K. Mohapatra, "Energy-efficient modified LEACH protocol for IoT application", *IET Wireless Sensor System* 2018, Vol. 8, Issue 5, pp.223–228, 2018.
- [34] M.S.Obaidat, S.Misra, "Principles of Wireless Sensor Networks", Cambridge Univ. Press: Cambridge, UK, 2014.
- [35] D. Kim and Y. Chung, "Self-Organization Routing Protocol Supporting Mobile Nodes for Wireless Sensor Network," *First International Multi-Symposiums on Computer and Computational Sciences (IMSCCS'06)*, pp. 622-626, 2006. doi: 10.1109/IMSCCS.2006.265.
- [36] Hicham Ouchitachen, Abdellatif Hair, Najlae Idrissi, "Improved multi-objective weighted clustering algorithm in Wireless Sensor Network", *Egyptian Informatics Journal*, volume 18, Issue 1, pp 45–54, 2017.
- [37] Vasudha and A. Bhola, "Investigations on Lifetime and Energy Optimization of WSN based on Hybrid Clustering Algorithm," 2019 6th International Conference on Computing for Sustainable Global Development (INDIACom), New Delhi, India, 2019, pp. 932-937, 2019.

RESEARCH ARTICLE

Authors



Vasudha has completed Master in Technology in Computer Science and at present Research Scholar in Department of Computer Science, Banasthali Vidyapith. Her research areas are Wireless Sensor Networks, Computer Networks and Data Communications.



Dr. Anoop Kumar has done his Ph.D. from Banasthali Vidyapith, Rajasthan. His research areas are Wireless Sensor Networks, Cloud Computing, IoT and Mobile Computing. Currently he is working as Assistant Professor of Computer Science Engineering Department, Banasthali Vidyapith

How to cite this article:

Vasudha, Anoop Kumar, “Probabilistic Based Optimized Adaptive Clustering Scheme for Energy-Efficiency in Sensor Networks”, International Journal of Computer Networks and Applications (IJCNA), 8(3), PP: 188-202, 2021, DOI: 10.22247/ijcna/2021/209187.